



## Ditec ION4-ION6

### Sliding gates

(translation of the original instructions)

IP2288EN • 2018-02-26

Technical Manual

# Contents

	Subject	Page
<b>1.</b>	<b>General safety precautions</b>	<b>3</b>
	General safety precautions for the user	4
<b>2.</b>	<b>Declaration of incorporation of partly completed machinery</b>	<b>5</b>
2.1	Machinery Directive	5
<b>3.</b>	<b>Technical specifications</b>	<b>6</b>
<b>4.</b>	<b>Standard installation</b>	<b>7</b>
<b>5.</b>	<b>Dimensions</b>	<b>8</b>
<b>6.</b>	<b>Main components</b>	<b>8</b>
<b>7.</b>	<b>Installation</b>	<b>9</b>
7.1	Preliminary checks	9
7.2	Base plate position	9
7.3	Gearmotor installation	10
7.4	Rack installation	11
7.5	Operation with virtual encoder	12
7.6	Installation of optional accessories	12
7.6.1	Magnetic limit switches	12
7.6.2	Battery kit	12
7.6.3	Remote release handle	12
<b>8.</b>	<b>Electrical connections</b>	<b>13</b>
<b>9.</b>	<b>LCU48 card</b>	<b>14</b>
<b>10.</b>	<b>Using of the menus</b>	<b>15</b>
10.1	Switching the display on and off	15
10.2	Navigation keys	15
10.3	Menu map	16
<b>11.</b>	<b>Product start-up</b>	<b>18</b>
11.1	WZ configuration wizard menu	18
<b>12.</b>	<b>Commands</b>	<b>20</b>
12.1	SOFA1-SOFA2 or GOPAVRS self-controlled safety edge	21
<b>13.</b>	<b>Outputs and accessories</b>	<b>21</b>
<b>14.</b>	<b>Jumper setting</b>	<b>22</b>
<b>15.</b>	<b>Adjustments</b>	<b>23</b>
15.1	Main menu	23
15.2	Second level menu - AT (Automatic Configurations)	24
15.3	Second level menu - BC (Basic Configurations)	25
15.3.1	Additional BC level parameters that can be configured (available with AT → AA enabled)	26
15.4	Second level menu - BA (Basic Adjustment)	27
15.4.1	Additional BA level parameters that can be configured (available with AT → AA enabled)	28
15.5	Second level menu - RO (Radio Operations)	30
15.5.1	Additional RO level parameters that can be configured (available with AT → AA enabled)	31
15.6	Second level menu - SF (Special Functions)	32
15.6.1	Additional SF level parameters that can be configured (available with AT → AA enabled)	33
15.7	Second level menu - CC (Cycle Counter)	34
15.7.1	Additional CC level parameters that can be configured (available with AT → AA enabled)	35
15.8	Second level menu - EM (Energy Management)	35
15.8.1	Additional EM level parameters that can be configured (available with AT → AA enabled)	36
15.9	Second level menu - AP (Advanced Parameters)	36
15.9.1	Additional AP level parameters that can be configured (available with AT → AA enabled)	38
<b>16.</b>	<b>Signals visualised on the display</b>	<b>40</b>
16.1	Display of automation status	40
16.2	Display of safety devices and commands	42
16.3	Display of alarms and faults	43
<b>17.</b>	<b>Troubleshooting</b>	<b>46</b>

# 1. General safety precautions



Please follow these instructions. Failure to observe the information given in this manual may lead to personal injury or damage to the equipment.  
Keep these instructions for future reference.

This installation manual is intended for qualified personnel only. Installation, electrical connections and adjustments must be performed by qualified personnel, in accordance with Good Working Methods and in compliance with the current regulations. Read the instructions carefully before installing the product.

Bad installation could be dangerous.

This manual and those for any accessories can be downloaded from [www.entrematic.com](http://www.entrematic.com).



The packaging materials (plastic, polystyrene, etc.) should not be discarded in the environment or left within reach of children, as they are a potential source of danger.

Before installing the product, make sure it is in perfect condition.

Do not install the product in explosive areas and atmospheres: the presence of inflammable gas or fumes represents a serious safety hazard.

Before installing the motorisation device, make all the necessary structural modifications to create safety clearance and to guard or isolate all the crushing, shearing, trapping and general hazardous areas.

Make sure the existing structure is up to standard in terms of strength and stability. The motorisation device manufacturer is not responsible for failure to observe Good Working Methods when building the frames to be motorised, or for any deformation during use.

The safety devices (photocells, safety edges, emergency stops, etc.) must be installed taking into account: applicable laws and directives, Good Working Methods, installation premises, system operating logic and the forces developed by the motorised door or gate.

The safety devices must protect against crushing, cutting, trapping and general danger areas of the motorised door or gate.



Display the signs required by law to identify hazardous areas.

Each installation must bear a visible indication of the data identifying the motorised door or gate.

When necessary, connect the motorised door or gate to an effective earthing system that complies with the current safety standards.

During installation, maintenance and repair operations, cut off the power supply before opening the cover to access the electrical parts.



The automation protection casing must be removed by qualified personnel only.

The electronic parts must be handled using earthed antistatic conductive arms. The manufacturer of the motorisation declines all responsibility if component parts not compatible with safe and correct operation are fitted.

Only use original spare parts for repairing or replacing products.

The installer must supply all information concerning the automatic, manual and emergency operation of the motorised door or gate, and must provide the user with the operating instructions. The installer must ensure that the temperature range indicated in the technical specifications is compatible with where the gate will be used.

# General safety precautions for the user



These precautions are an integral and essential part of the product and must be supplied to the user.

Read them carefully since they contain important information on safe installation, use and maintenance.

These instructions must be kept and forwarded to all possible future users of the system.

This product must only be used for the specific purpose for which it was designed.

Any other use is to be considered improper and therefore dangerous. The manufacturer cannot be held responsible for any damage caused by improper, incorrect or unreasonable use.

Avoid operating in the proximity of the hinges or moving mechanical parts. Do not enter within the operating range of the motorised door or gate while it is moving.

Do not obstruct the motion of the motorised door or gate, as this may cause a dangerous situation.

The motorised door or gate may be used by children over the age of 8 and by people with reduced physical, sensorial or mental abilities, or lack of experience or knowledge, as long as they are properly supervised or have been instructed in the safe use of the device and the relative hazards.

Children must be supervised to make sure they do not play with the device, nor play/remain in the sphere of action of the motorised door or gate.

Keep remote controls and/or any other command devices out of the reach of children, to avoid any accidental activation of the motorised door or gate.

In the event of a product fault or malfunction, turn off the power supply switch. Do not attempt to repair or intervene directly, and contact only qualified personnel.

Failure to comply with the above may cause a dangerous situation.

Any repair or technical intervention must be carried out by qualified personnel.

Cleaning and maintenance work must not be carried out by children unless they are supervised.

To ensure that the system works efficiently and correctly, the manufacturer's indications must be complied with and only qualified personnel must perform routine maintenance on the motorised door or gate. In particular, regular checks are recommended in order to verify that the safety devices are operating correctly.

All installation, maintenance and repair work must be documented and

made available to the user.

Only lock and release the door wings when the motor is switched off. Do not enter within the operating range of the wing.

 To dispose of electrical and electronic equipment correctly, users must take the product to special "recycling centres" provided by the municipal authorities.

## 2. Declaration of incorporation of partly completed machinery

(Directive 2006/42/EC, Annex II-B)

The manufacturer Entrematic Group AB, with headquarters in Lodjursgatan 10, SE-261 44 Landskrona, Sweden, declares that the Ditec ION4-ION6 automation for swing gates:

- is designed to be installed on a manual gate to form a machine pursuant to Directive 2006/42/EC. The manufacturer of the motorised gate must declare conformity with Directive 2006/42/EC (annex II-A) prior to initial machine start-up;
- complies with the applicable essential safety requirements indicated in Annex I, Chapter 1 of the Directive 2006/42/EC;
- complies with the Electromagnetic Compatibility Directive 2014/30/EU;
- complies with the RED Directive 2014/53/EU;
- the safety functions are compliant with Category 2, PLC according to EN ISO 13849-1;
- the technical documentation complies with Annex VII-B of the Directive 2006/42/EC;
- the technical documentation is managed by the Technical Office of Entrematic Italy (with headquarters in Largo U. Boccioni 1 – 21040 Origgio (VA) – ITALY) and is available upon request, sending an e-mail to [ditec@entrematic.com](mailto:ditec@entrematic.com) ;
- a copy of the technical documentation will be given to competent national authorities, following a suitably justified request.

Landskrona, 26-02-2018

Matteo Fio  
Chairman  

### 2.1 Machinery Directive

Pursuant to Machinery Directive (2006/42/EC) the installer who motorises a door or gate has the same obligations as the manufacturer of machinery and as such must:

- prepare the technical data sheet which must contain the documents indicated in Annex V of the Machinery Directive;  
(The technical data sheet must be kept and placed at the disposal of competent national authorities for at least ten years from the date of manufacture of the motorised door or gate);
- draw up the EC Declaration of Conformity in accordance with Annex II-A of the Machinery Directive and deliver it to the customer;
- affix the EC marking on the motorised door or gate, in accordance with point 1.7.3 of Annex I of the Machinery Directive;
- ensure compliance of the motorised door or gate with safety regulations, by installing the necessary safety devices;

# 3. Technical specifications

	ION4	ION4J	ION6	ION6J
Maximum stroke	12m			
Maximum gate weight	400Kg		600Kg	
Gate speed	0,1±0,3 m/s			
Thrust	200N nominal, 600N start-up		300N nominal, 800N start-up	
Power supply	230 V~ 50/60Hz	120 V~ 50/60Hz	230 V~ 50/60Hz	120 V~ 50/60Hz
Power absorption	0,45A	0,9A	0,6A	1,2A
Fuse	T1A	F2A	F1,6A	F3,15A
Power	100 W		130 W	
Intermittence	80 cycles/day, 30 continuous cycles			
Lifespan	From 50,000 to 150,000 cycles, depending on the conditions indicated in table (see the product lifespan charts)			
Acoustic pressure	LpA ≤ 70dB(A)			
IP degree of protection	44			
Usage temperature				
Product size	300 x 260 x 195			
Control panel	LCU48			
Motor output	24V  10A max			
Power supply to accessories	24V  0,3A max			
Radio frequency	433,92 MHz			
Storable radio codes	100 / 200 vedi RO → MU → 20/10			

Index of conditioning factors		
	ION4	ION6
Gate wing weight	>150Kg	-
	>200Kg	10
	>300Kg	20
	>400Kg	30
Gate wing width	>4m	10
	>8m	20
Wheel diameter <100mm	10	
Saline environment	10	
Safety edge installed	10	
R1/R2 > default	10	
VA/VC > default OC/CB < default	10	

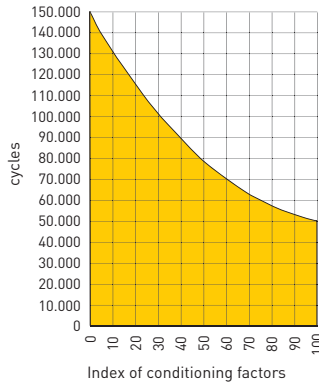

Example of lifespan calculation for ION4	
Gate wing weight >150Kg	10
Gate wing width > 4.5m	10
Dust	10
Safety edges installed	10
VA/VC > default	10
<b>Total stress index</b>	<b>50</b>
Estimated lifespan - 80,000 cycles	
Estimated daily cycles 22 (for 10 years)	

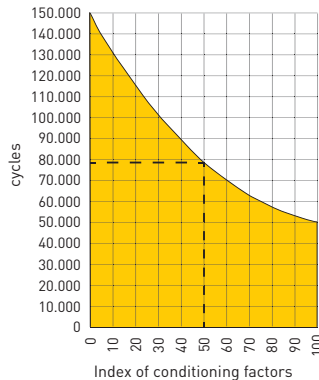

## 4. Standard installation

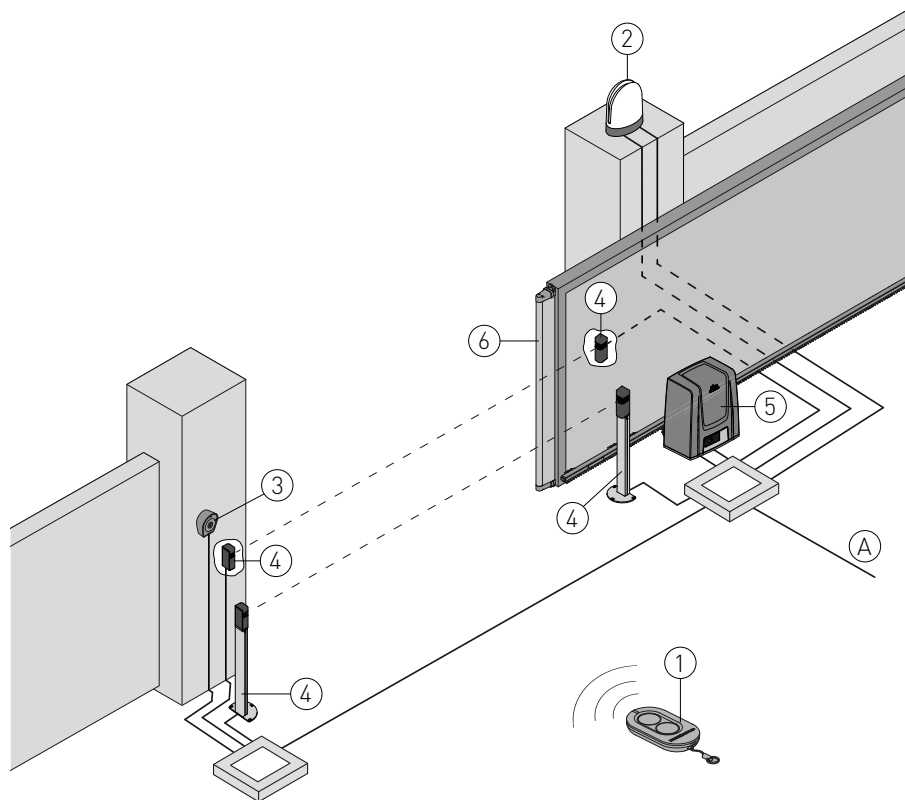

Rif.	Description	Cable
1	Remote control	/
2	Flashing light	2 x 1 mm <sup>2</sup>
	Antenna (integrated into the flashing light)	coaxial 58 Ω
3	Key selector switch	4 x 0,5mm <sup>2</sup>
	Digital combination wireless keypad	/
4	Photocells	4 x 0,5 mm <sup>2</sup>
5	Actuator ION with control panel	3G x 1,5 mm <sup>2</sup>
6	Safety edge	2 x 0,5 mm <sup>2</sup>
A	Connect the power supply to a type-approved omnipolar switch, with a contact opening distance of at least 3mm (not supplied). The connection to the mains must follow an independent path, separate from the connections to the control and safety devices.	

## 5. Dimensions

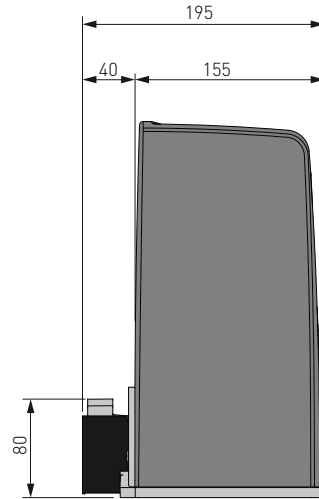
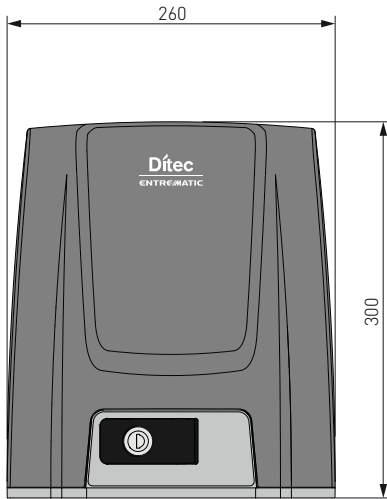

## 6. Main components

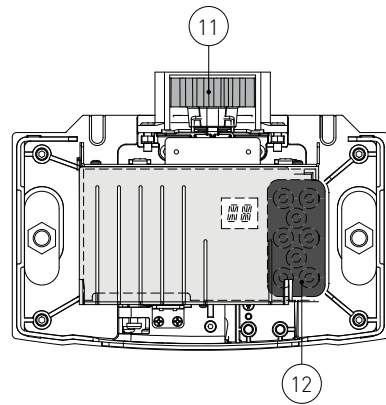
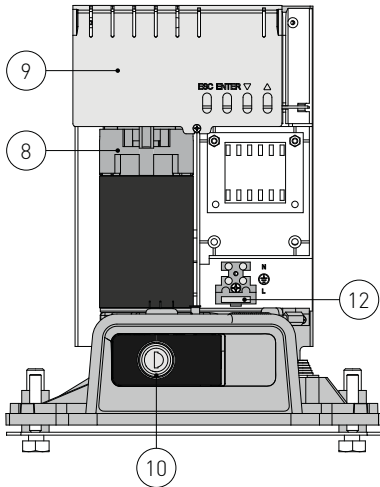

Rif.	Descrizione
8	Motor
9	Control panel
10	Key release
11	Pinion
12	Cable inlet
13	Power supply terminal and fuse



# 7. Installation

The given operating and performance features can only be guaranteed with the use of DITEC accessories and safety devices.

Unless otherwise specified, all measurements are expressed in mm.

## 7.1 Preliminary checks

Check the stability of the wing (derailing and lateral falls) and the sliding wheels and that the upper guides do not cause any friction.

The sliding guide must be securely fixed to the ground for the full length within doorway and must have no irregularities that could hinder the movement of the wing.

The opening and closing stops must be fitted.

If the gate has slits, make sure they are covered to prevent shearing points or install active safety edges on the columns.

Safety device should be installed at the end of the wing to reduce the collision force.



NB:

- Make sure that the gate can not exit the sliding guides and fall.
- Make sure that the protection system and any manual release function correctly.

## 7.2 Base plate position

Make a concrete base with the anchor ties and base plate embedded, which must be level and clean and of the size indicated in the figure.



NB: if the concrete base has already been made, base plate can be fixed using M8 plugs (not supplied).

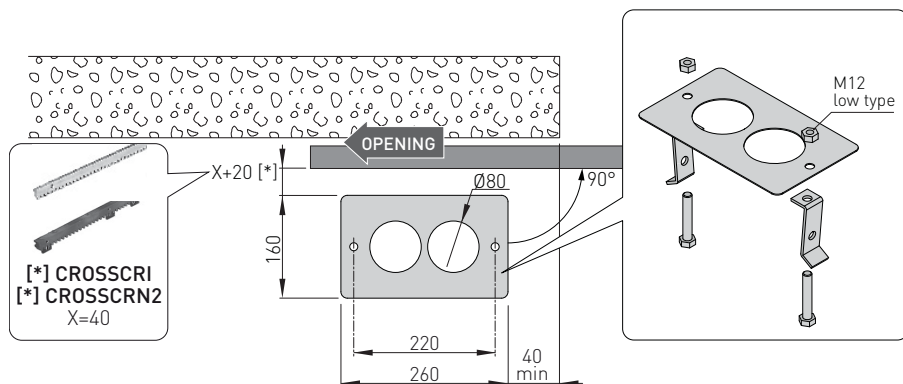

## 7.3 Gearmotor installation

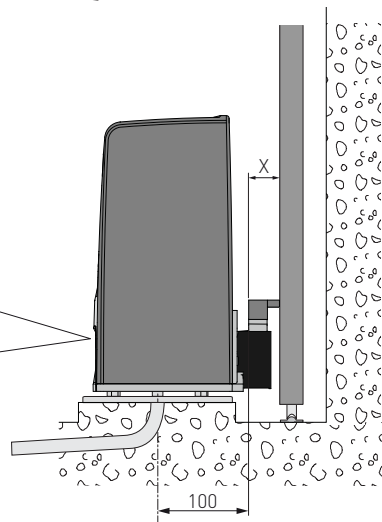
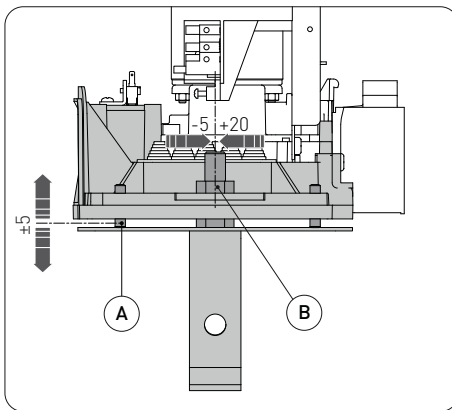
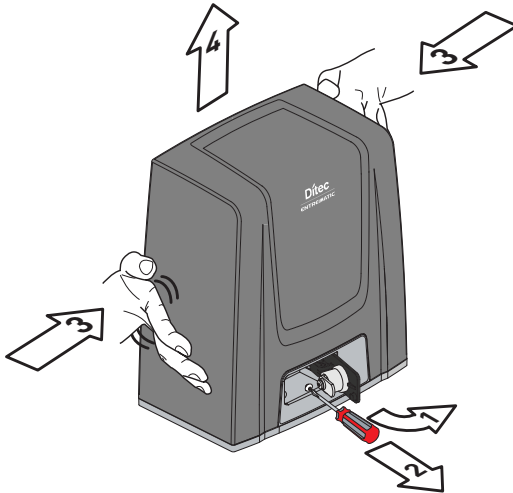

- Release the gearmotor [1] (see OPERATING INSTRUCTIONS). Loosen the front screw [2] and remove the casing by pressing on its sides [3-4].
- Place the gearmotor on the base plate.
- Adjust the gearmotor horizontally by sliding it along the slots of the gearmotor base and vertically with four levelling screws [A].  
NB: during the vertical adjustment, keep the gearmotor slightly raised from the base plate so that the rack can be fixed and subsequent adjustments are possible.
- After adjusting, fix the gearmotor using screws [B].



**WARNING:** The gearmotor must be suitably raised from the ground to avoid flooding. Tighten the [B] screws using a tightening torque of 20-25 Nm.

## 7.4 Rack installation

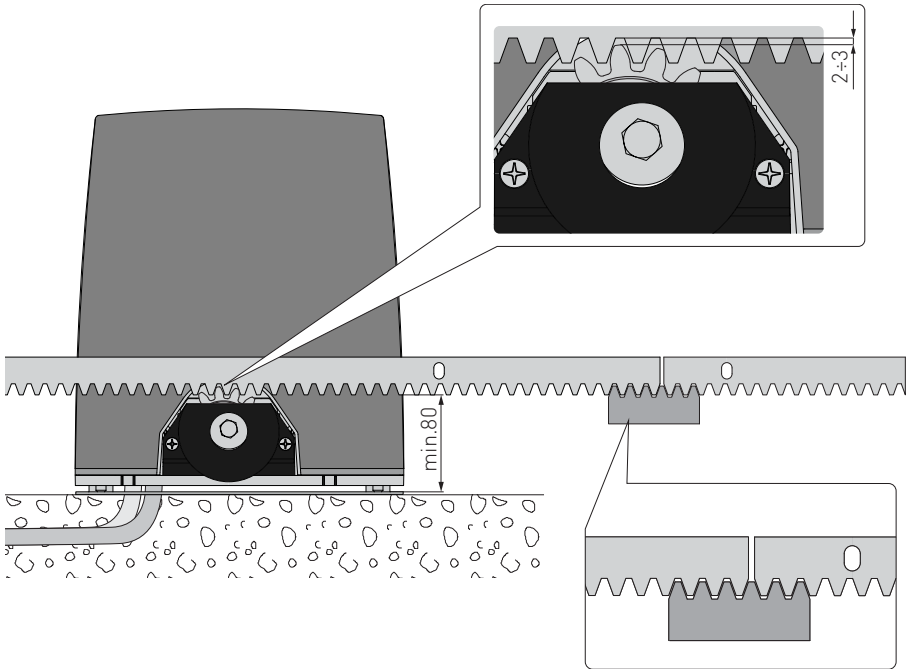

- Release the gearmotor (see OPERATING INSTRUCTIONS) and open the gate.
  - Place the rack against the pinion and sliding the gate manually fix it along its whole length.
- NB: To make it easier to align the rods correctly, use a scrap piece of rack and rest it underneath the junction point, as shown in the figure detail.
- Once fixed, vertically adjust the gearmotor to give a play of about 2 to 3 mm between the pinion and the rack.
  - Secure the gearmotor with the [B] screws using a tightening torque of 20-25 Nm.
  - Slightly lubricate the rack and pinion after assembly.
- Manually check that the gate slides evenly and without friction.

## 7.5 Operation with virtual encoder

ION4-ION6 gearmotors do not require limit switches because they have a virtual encoder.

Mechanical opening and closing end stops must be installed.

The gate automatically slows when approaching the end stops.

**WARNING:** when the gate reaches the opening or closing limit stop, it reverses briefly to facilitate manual release of the gearmotor.

## 7.6 Installation of optional accessories

### 7.6.1 Magnetic limit switches



The limit switch kit is used to stop the gate before it reaches the opening and closing mechanical stops.

With a limit switch installed, slowdown is carried out at regulated power to overcome possible friction.

For the installation of the limit switch kit, refer to the **NES100FCM** manual.

To position the limit switches, you can use the menu **SF** → **TF** (visible by activating the additional configurations **AT** → **AA**).

The display shows the status of the limit switches:

- **FA**: opening limit switch configured and activated;
- **FC**: closing limit switch configured and activated;
- **NQ** (both parts of display active): opening limit switch not configured and activated;
- **NO** (no part of display active): closing limit switch not configured and activated;
-  (central part of display active): no limit switch activated;

### 7.6.2 Battery kit

For installation of the battery kit, refer to the **SBU-BBU20-BBU65** manual.



The battery kit guarantees operation if there is a power cut.

For advanced control of battery-powered operation, refer to the EM menu.

### 7.6.3 Remote release handle

For installation of the remote release handle, refer to the **IONSBM** and **ASR2** manual.



The kit can be used to remotely release the gearmotor.

A microswitch guarantees safety.

When the handle is released, the control panel performs a reset

## 8. Electrical connections

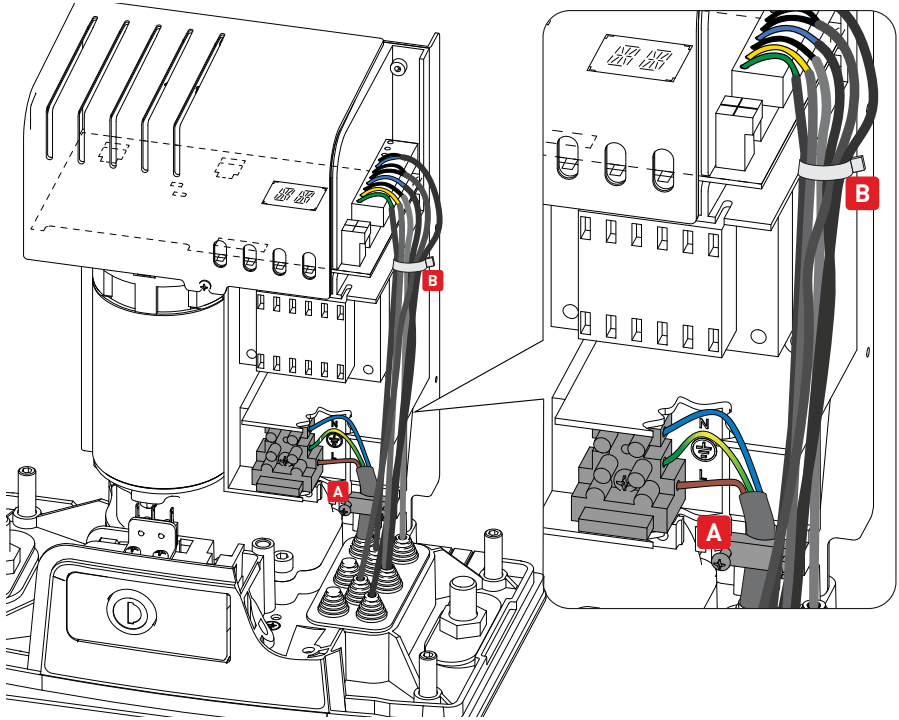

Before connecting the power supply, make sure the plate data correspond to that of the mains power supply.

An omnipolar disconnection switch with a contact opening distance of at least 3mm must be fitted on the mains supply.

Check there is an adequate residual current circuit breaker and overcurrent cutout upstream of the electrical system.

For the power supply, use a H05RN-F 3G1.5 type electric cable. Connect it to terminals L (brown), N (blue),  $\oplus$  (yellow/green) inside the automation.

**NOTE:** the maximum permissible section of the wire is AWG14 [2 mm<sup>2</sup>].

In order to comply with essential requirements of standards in force, reclose the cover once the wires have been connected to the terminal.

In the external automation section, the connections to the mains power supply and any other low voltage wires (230V) must be made on an independent channel separated from the connections to the command and safety devices (SELV = Safety Extra Low Voltage).

The channel must penetrate the automation through the holes on the base plate by a few centimetres.

Make sure there are no sharp edges that may damage the power supply cable.

Make sure the mains power wires (230V) and the accessory wires (24V) are separated. The cables must be double insulated. Unsheathe them in line with the relative connection terminals, and use cable fasteners (see ref. A) or straps (not supplied by us) to hold them in place.

# 9. LCU48 card

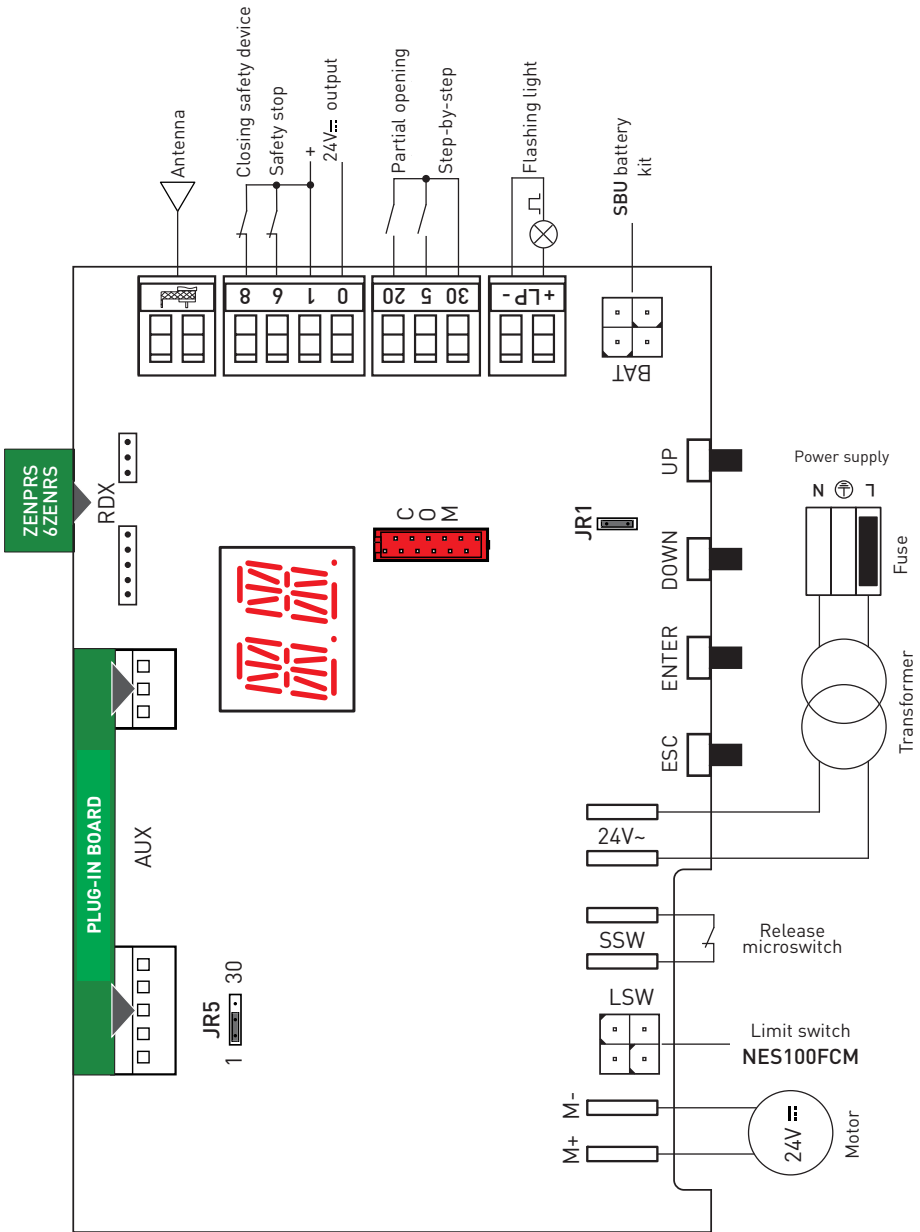

# 10. Using of the menus



NB: pressure on the keys may be quick (less than 2 s) or prolonged (longer than 2 s). Unless specified otherwise, quick pressure is intended.  
To confirm the setting of a parameter, prolonged pressing is necessary.

## 10.1 Switching the display ON and OFF

The procedure to switch on the display is as follows:



- press the ENTER key
- the display functioning check starts
- the first level menu is displayed

The procedure to switch off the display is as follows:

- press the ESC key

NB: there is no automatic exit from the WZ quick configuration menu. For all the other menus, the display switches off automatically after 60 seconds of inactivity.

## 10.2 Navigation keys

- The simultaneous pressing of the and ENTER keys produces an opening command.

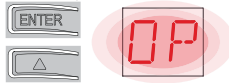

- The simultaneous pressing of the and ENTER keys produces a closing command.

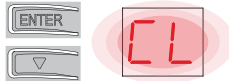

- The simultaneous pressing of the and keys produces a POWER RESET command (power supply interruption and automation restart).

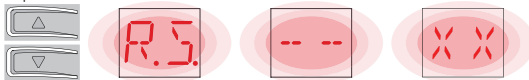

- Keep the UP or DOWN key pressed to begin fast menu scrolling.

To set a parameter, select the desired value and press ENTER for 2 seconds to save.

Example: setting of 30 seconds for parameter TC



- In some menus, the parameter measurement unit can be viewed by pressing the ENTER key once the value has been displayed.

# 10.3 Menu map

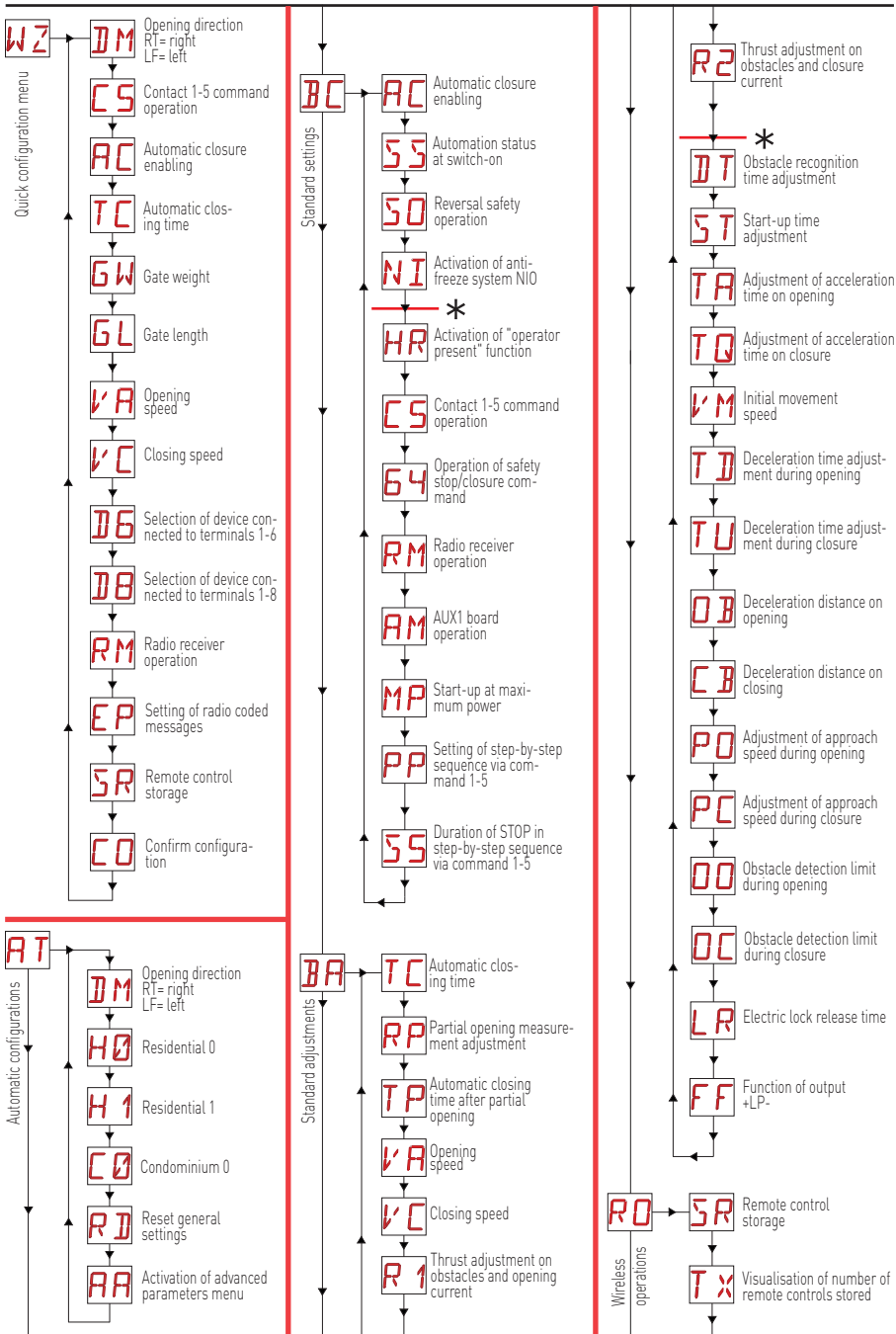



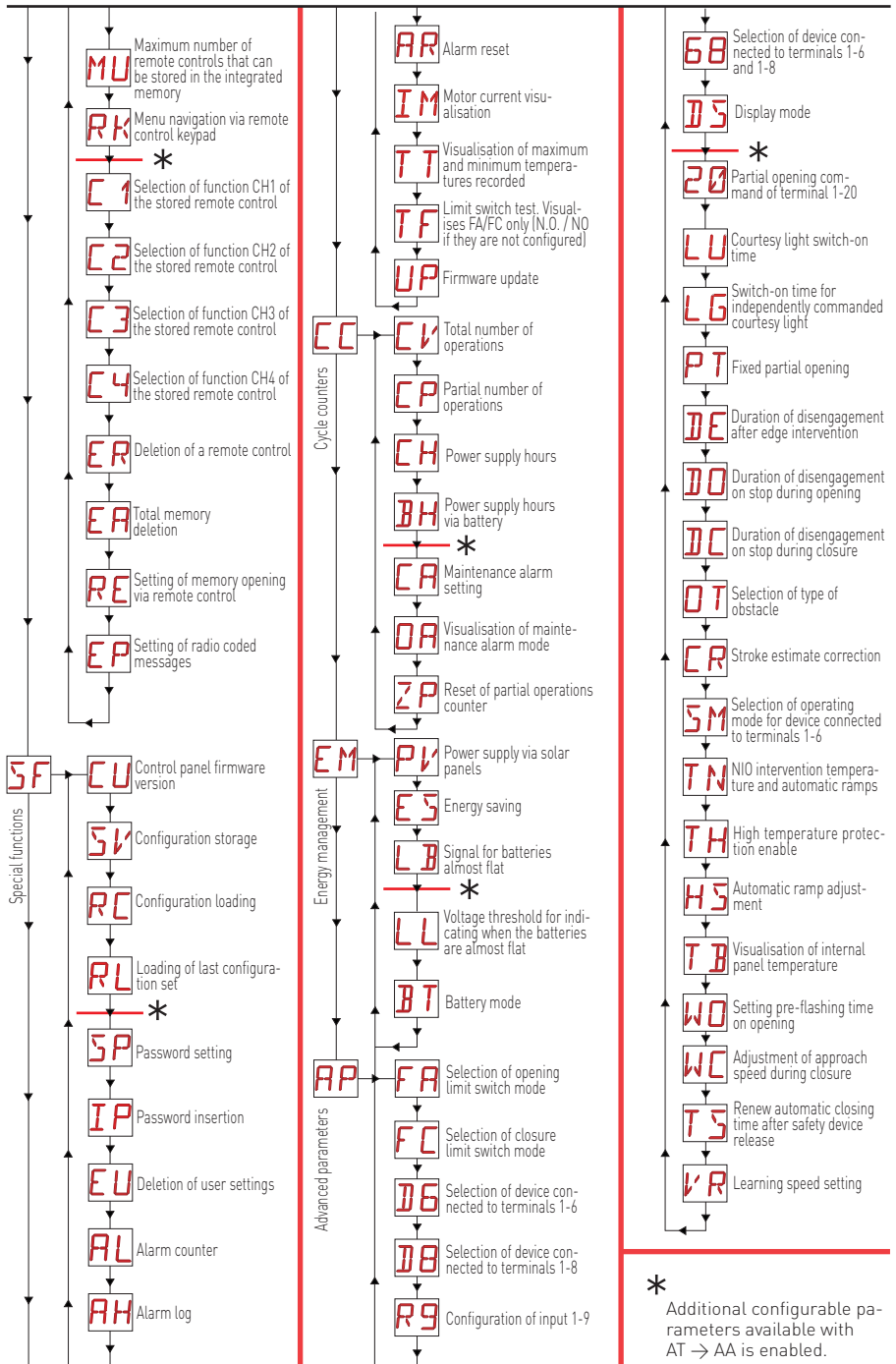

# 11. Product start-up

For rapid configuration of the product, use the WIZARD (WZ) menu or the second level AT (Automatic Configurations) menu [See par. 15.2].

For detailed, customised configuration, use the main menus BC, BA, RO, SF, CC, EM, AP.

## 11.1 WZ configuration wizard menu

### To access the WZ configuration wizard menu:

Hold down the ENTER button for 2 seconds.

When OK has stopped flashing, DM, the first menu parameter, is displayed.



### To set a parameter:













1. Press ENTER to access the configuration items.
2. Scroll UP/DOWN the possible options.
3. To confirm, press the ENTER button for 2 seconds. The selected value flashes and when it has finished, the next parameter appears.



Display	Description
DM	<b>DM - Selection of opening direction (looking at the automation from the side being examined)</b> <ul style="list-style-type: none"> <li>• RT: opens to the right  (default)</li> <li>• LF: Opens to the left</li> </ul>
CS	<b>C5 - Operation of command associated with contact 30-5</b> <ul style="list-style-type: none"> <li>• 1-5: step-by-step  (default)</li> <li>• 1-3: Opening</li> </ul>
AC	<b>AC - Enabling of automatic closure</b> <ul style="list-style-type: none"> <li>• ON: enabled  (default)</li> <li>• OF: disabled</li> </ul>
TC	<b>TC - Setting of automatic closing time [seconds]</b> [N.B.: only visible if you have selected AC = ON in the previous step] <ul style="list-style-type: none"> <li>• from 0" to 59" with intervals of 1 second.</li> <li>• - from 1'  (default) to 2' with intervals of 10 seconds.</li> </ul>
GW	<b>GW - Selection of gate weight.</b> The selected value sets parameters R1 and R2 to adjust the maximum thrust current of the motor. <ul style="list-style-type: none"> <li>• LG: up to 200 kg → (R1=R2=30%)</li> <li>• MG: between 200 kg and 300 kg for ION4 and ION4J, between 200 kg and 400 kg for ION6 and ION6J → (R1=R2=50%)  (default)</li> <li>• HG: between 300 kg and 400 kg for ION4 and ION4J; between 400 kg and 600 kg for ION6 and ION6J → (R1=R2=70%)</li> </ul>
GL	<b>GL - Selection of gate length</b> The selected value sets parameters OB and CB for adjusting the deceleration space <ul style="list-style-type: none"> <li>• 02: between 0 and 2 m → (OB=CB=50cm)</li> <li>• 04: between 2 and 4 m → (OB=CB=60cm)  (default)</li> <li>• 06: between 4 and 6 m → (OB=CB=70cm)</li> <li>• &gt;6: over 6 m → (OB=CB=80cm)</li> </ul>
VA	<b>VA - Selection of opening speed</b> <ul style="list-style-type: none"> <li>• L0: 15 cm/s</li> <li>• ME: 20 cm/s  (default)</li> <li>• HI: 25 cm/s</li> </ul>

WZ - Wizard

IP2288EN

	<b>VC - Selection of closing speed</b> <ul style="list-style-type: none"> <li>• LO: 15 cm/s</li> <li>• ME: 20 cm/s  (default)</li> <li>• HI: 25 cm/s</li> </ul>
	<b>D6 - Selection of device connected to terminals 1-6</b> <ul style="list-style-type: none"> <li>• NO: none</li> <li>• PH: photocells  (default)</li> </ul> For other options, see the specific menu.
	<b>D8 - Selection of device connected to terminals 1-8</b> <ul style="list-style-type: none"> <li>• NO: none</li> <li>• PH: photocells  (default)</li> </ul> For other options, see the specific menu.
	<b>RM - Radio receiver operation</b> <ul style="list-style-type: none"> <li>• 1-3: Step-by-step</li> <li>• 1-5: opening  (default)</li> </ul>
	<b>EP - Setting the coded area messages</b> If the possibility to receive coded messages is enabled, the control panel will be compatible with remote controls of the "ENCRYPTED" type. <ul style="list-style-type: none"> <li>• ON: enabled</li> <li>• OF: disabled  (default)</li> </ul>
	<b>SR - Remote control storage</b> When you press ENTER, SR starts to flash and you can associate the desired buttons. Once OK is displayed, SR starts to flash again and you can associate the next button. To quit, press ESC or ENTER for 2 seconds and go on to the next item. NB: if NO flashes on the display, the remote control may already be stored.
	<b>CO - Saving of parameters</b> Here you can save the parameters that have previously been set. <ul style="list-style-type: none"> <li>• YS: to save and perform a card RESET</li> <li>• NO: to quit without saving and go back to a blank screen (central part only)</li> </ul> NB: the CO item and YS/NO sub-menus flash constantly.

**To save the configuration:**

In the CO parameter select YS (yes) and press the ENTER button for 2 seconds.

When the configuration has been saved, a power reset is automatically performed on the card.



**To quit without saving changes:**

In the CO parameter select NO and press the ENTER button for 2 seconds.



Or: from any main parameter, press the ESC button for 2 seconds.

Example

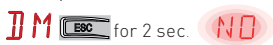

**NOTES**

- The set values are only stored on the card if they are saved using the CO parameter.
- The CO parameter and YS/NO options flash constantly.
- When a configuration item is confirmed, it automatically moves on to the next parameter.
- You can scroll through the menu parameters using the UP/DOWN buttons.
- There is no automatic timeout function to quit.







# 12. Commands



You are advised to read paragraph 15 for all the details about the possible adjustments.



**WARNING:** terminal 30 (common positive for commands) has the same functions as terminal 1, so the commands visualised on the display are indicated with 1-5, 1-3, etc. It is different from terminal 1, however, because of the maximum current that can be dispensed and it is also active when the control panel is in standby **ES** → **DN**.

Command	Function	Description
30  5	NO	<b>STEP-BY-STEP</b> When selecting <b>BC</b> → <b>CS</b> → <b>1-5</b> , the closure of the contact activates a sequential opening or closing operation: opening-stop-closing-opening. WARNING: if automatic closure is enabled, the duration of the stop can be defined by selecting <b>BC</b> → <b>SS</b> . The "opening-stop-closing-opening" sequence can be changed to "opening-stop-closing-stop-opening" by selecting <b>BC</b> → <b>PP</b> .
	OPENING	
1  6	NO	<b>CLOSURE</b> When selecting <b>BC</b> → <b>64</b> → <b>1-4</b> , closing the contact activates a closing operation.
1  6	NC	<b>SAFETY STOP</b> When selecting <b>BC</b> → <b>64</b> → <b>1-6</b> , opening of the safety contact stops and prevents any movement. NB: to set different safety contact functions, see the <b>AP</b> → <b>SM</b> parameter settings.
1  8	NC	<b>CLOSING SAFETY DEVICE</b> The opening of the safety contact triggers a reversal of the movement (reopening) during the closing operation. When selecting <b>BC</b> → <b>SO</b> → <b>ON</b> , the opening of the contact prevents any operation when the automation is idle. When selecting <b>BC</b> → <b>SO</b> → <b>OF</b> , the opening of the contact only prevents closure when the automation is idle.
1  6 8	NC	<b>CLOSING/ OPENING SAFETY DEVICE</b> The opening of the safety contact stops and prevents any movement. NB: operation corresponds to that of contact 1-6 with <b>AP</b> → <b>SM</b> → <b>05</b> .
1  20	NO	<b>PARTIAL OPENING</b> The closure of the contact activates a partial opening operation. Once the automation stops, the partial opening control performs the opposite operation to the one performed before the stop.
1  20	NC	<b>AUTOMATIC CLOSURE OR STOP</b> Selecting <b>AP</b> → <b>20</b> → <b>1-2</b> , the permanent closure of the contact enables automatic closure if <b>AC</b> → <b>1-2</b> . Selecting <b>AP</b> → <b>20</b> → <b>1-9</b> , the opening of the safety contact causes the movement to stop. NB: the flashing light flashes.







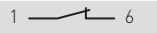
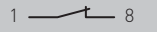
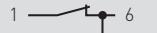

**WARNING:** make a jumper for all NC contacts if not used, or deactivate them via the relative menu. Terminals with the same number are equal.

## 12.1 SOFA1-SOFA2 or GOPAVRS self-controlled safety edge

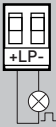
Command		Function	Description
		SAFETY TEST	Insert the SOFA1-SOFA2 or GOPAVRS device in the slot for plug-in boards AUX1 or AUX2. If the test fails, an alarm message appears on the display.
	NC	SAFETY STOP	When selecting <b>AP</b> → <b>DB</b> → <b>54i</b> , connect the output contact of the safety device to terminals 1-6 on the control panel (in series with the photocell output contact, if installed).
	NC	CLOSURE SAFETY DEVICE	When selecting <b>AP</b> → <b>DB</b> → <b>54i</b> , connect the output contact of the safety device to terminals 1-8 on the control panel (in series with the photocell output contact, if installed).
	NC	CLOSING/ OPENING SAFETY DEVICE	When selecting <b>AP</b> → <b>6B</b> → <b>54i</b> , connect the output contact of the safety device to terminals 1-6-8 on the control panel (in series with the photocell output contact, if installed). If <b>6B</b> → <b>54i</b> , <b>DB</b> and <b>DB</b> cannot be <b>P4i</b> or <b>54i</b> .



## 13. Outputs and accessories

Output	Value of accessories	Description
	24V $\overline{=}$ / 0.3A	<b>Power supply to accessories</b> Output for power supply to external accessories. NB: the maximum absorption of 0.3A corresponds to the sum of all terminals 1.
	GOL148REA	If the ZENPRS radio receiver is used (868.35 MHz), connect the supplied antenna wire (90mm).
	FLM FL24 $\overline{=}$ 24V / 25W	<b>Flashing light</b> The pre-flashing settings can be selected from the third level menu <b>AP</b> → <b>WD</b> and/or <b>AP</b> → <b>WC</b> . To modify the operating mode of the LP output, refer to the selection <b>BA</b> → <b>FF</b> .
AUX	SOFA1-SOFA2 GOPAVRS LAB9 BIXR2 BIXPR2 BIXLR42 LAN7S	The control panel has a slot for plug-in command and safety cards. The action of the control card can be defined by selecting <b>BC</b> → <b>AM</b> . When using slot-in radio boards, remove the RDX module. The display will show <b>RV</b> . WARNING: the plug-in board must be inserted and removed with the power supply disconnected.

Output	Value of accessories	Description
<b>RDX</b> 	6ZENRS ZENPRS	<p>The control panel is fitted with a housing for modules of the 6ZENRS radio receiver type (433.92 MHz). Can be replaced with a module of the ZENPRS radio receiver type (868.35 MHz).</p> <p>When using slot-in radio boards, remove the RDX module. The display will show <b>RV</b>.</p> <p><b>WARNING:</b> the modules must be inserted and removed with the power supply disconnected.</p>
<b>COM</b> 	BIXM R2	<p>COM - This allows the functioning configurations to be saved using the function <b>SF</b> → <b>SV</b>.</p> <p>The saved configurations can be recalled using the function <b>SF</b> → <b>RC</b>.</p> <p>COM - The storage module allows the remote controls to be stored. If the control panel is replaced, the storage module being used can be inserted in the new control panel.</p> <p><b>WARNING:</b> the storage module must be inserted and removed with the power supply disconnected, and paying attention to the positioning direction.</p>
<b>BAT</b> 	SBU	<p><b>BAT - Battery-powered operation.</b></p> <p>The batteries are kept charged when the power supply is on. If the power supply is off, the panel is powered by the batteries until the power is re-establish or until the battery voltage drops below the safety threshold. The control panel turns off in the last case. <b>WARNING:</b> the batteries must always be connected to the control panel for charging. Periodically check the efficiency of the batteries.</p> <p>NB: the operating temperature of the rechargeable batteries is from +5°C to +40°C.</p> <p>For advanced control of battery-powered operation, refer to the menu <b>EM</b>.</p>

## 14. Jumper setting

Jumper	Description	OFF	ON
JR1	Display mode selection.	<p><b>Display mode.</b></p> <p>Only the values and parameters present can be displayed.</p>	<p><b>Maintenance mode.</b></p> <p>Only the values and parameters present can be displayed and modified. Activated maintenance mode is indicated by the permanent switching on of the right-hand point on the display.</p>

Jumper	Description	1 30	1 30
JR5	Selection of power supply - auxiliary board.		
		AUX1 powered from 0-1. (default)	AUX1 powered from 0-30.

# 15. Adjustments



NB: depending on the type of automation and control panel, some menus may not be available.

## 15.1 Main menu

Display	Description
WZ	<b>WZ - Wizard</b> Quick configuration menu
AT	<b>AT - Automatic Configurations.</b> The menu allows you to manage the automatic configurations of the control panel.
BC	<b>BC - Basic Configurations.</b> The menu allows you to display and modify the main settings of the control panel.
BA	<b>BA - Basic Adjustments.</b> The menu allows you to display and modify the main adjustments of the control panel. NB: some settings require at least three operations before they are set correctly.
RO	<b>RO - Radio Operations.</b> The menu is used to manage the radio functions of the control panel (alarm management, diagnostics enabling, FW updating).
SF	<b>SF - Special Functions.</b> The menu allows you to set the password and manage the special functions in the control panel.
CC	<b>CC - Cycles Counter.</b> The menu allows you to display the number of operations carried out by the automation and manage the maintenance interventions.
EM	<b>EM - Energy Management.</b> The menu allows you to display and modify the energy saving settings and adjustments (Green Mode and battery management).
AP	<b>AP - Advanced Parameters.</b> The menu allows you to display and modify the advanced settings and adjustments of the control panel (limit switch mode, selection of devices connected to the terminals, disengagement duration adjustments, flashing light adjustments, etc.). NB: some settings require at least three operations before they are set correctly.

From the main menu you can access the second level menu as follows:

- use the  and  keys to select the required function
- press  to confirm

After confirming the selection, you access the second level menu.

For each function of the main menu, there are also additional configurations that can be viewed by enabling the **AA** function (see the following paragraph).



NB: to check if the parameters have actually been modified, quit the relative parameter and then access it again.  
The modifications will take effect from the next operation.

## 15.2 Second level menu - AT (Automatic Configurations)

Display	Description	Selections available
	<b>DM - Direction mode</b> RT-opens to the right LF-open to the left	
	<b>H0 - Predefined setting, residential use 0</b> This selection loads predefined values for certain standard parameters: AC - enabling of automatic closing : 1-2 C5 - step-by-step/opening command operation : Step-by-step RM - remote control operation : Step-by-step AM - AUX plug-in board operation : Step-by-step SS - Selection of automation status at start-up : open	
	<b>H1 - Predefined setting, residential use 1</b> This selection loads predefined values for certain standard parameters: AC - enabling of automatic closing : enabled TC - setting of automatic closing time : 1 minute C5 - step-by-step/opening command operation : Step-by-step RM - remote control operation : Step-by-step AM - AUX plug-in board operation : Step-by-step SS - Selection of automation status at start-up : closed	
	<b>C0 - Predefined setting, condominium use 0</b> This selection loads predefined values for certain standard parameters: AC - Enabling of automatic closure : enabled TC - setting of automatic closing time : 1 minute C5 - step-by-step/opening command operation : Opening RM - remote control operation : Opening AM - AUX plug-in board operation : Opening SS - Selection of automation status at start-up : closed	
	<b>RD - Resetting of general settings (SETTINGS RESET)</b> 	
	<b>AA - Activation of additional configurable parameters for each function of the main menu.</b> 	
	After activation you can scroll through the third level menus. The third level menus are activated for 30 min.	

AT - Automatic configurations



## 15.3 Second level menu - BC (Basic Configurations)

BC - Basic configurations	Display	Description	Selections available
	AC	<b>AC - Enabling of automatic closure</b> ON - Enabled 1-2 - Dependent on input 1-2	ON1-2 <span style="border-bottom: 1px solid green; display: inline-block; width: 1em;"></span>
	SS	<b>SS - Selection of automation status at start</b> OP - Open CL - Closed Indicates how the control panel considers the automation at the time of switch-on, or after a POWER RESET command.	OP CL <span style="border-bottom: 1px solid green; display: inline-block; width: 1em;"></span>
	SO	<b>SO - Enabling of reversal safety contact functioning</b> ON - Enabled OF - Disabled When enabled (ON) with the automation idle, if the contact 1-8 is open, all operations are prevented. When disabled (OF) with the automation idle, if the contact 1-8 is open, opening operations are permitted.	ON <span style="border-bottom: 1px solid green; display: inline-block; width: 1em;"></span>  OF
	NI	<b>NI - Enabling of NIO electronic anti-freeze system</b> ON - Enabled OF - Disabled When enabled (ON), it maintains the efficiency of the motor even at low ambient temperatures. NB: for correct operation, the control panel must be exposed to the same ambient temperature as the motors. The intervention temperature for NIO can be set by selecting <b>AP</b> → <b>TN</b> .	ON   OF <span style="border-bottom: 1px solid green; display: inline-block; width: 1em;"></span>

### 15.3.1 Additional BC level parameters that can be configured (available with **AT** → **AA** enabled)

BC	Display	Description	Selections available	
	<b>HR</b>	<b>HR - Enabling of "operator present" function</b> ON - Enabled OF - Disabled NB: Set <b>HR</b> → <b>ON</b> only if <b>64</b> → <b>1-4</b> and <b>65</b> → <b>1-3</b> .  <b>WARNING:</b> • If the OPERATOR PRESENT function is activated, make sure that no-one is near the automation when an opening or closing command is given. • The actuation device for the OPERATOR PRESENT function must be placed within the visibility of the guided part but away from the moving parts. It must also be installed at a minimum height of 1.5 m and be placed out of the public's reach.	<b>ON</b>	<b>OF</b>
	<b>CS</b>	<b>C5 - Operation of command associated with contact 30-5</b> 1-5 - Step-by-step 1-3 - Opening	<b>1-5</b>	<b>1-3</b>
	<b>64</b>	<b>64 - Functioning of safety stop/closing command.</b> 1-4 - Closing 1-6 - Safety stop	<b>1-4</b>	<b>1-6</b>
	<b>RM</b>	<b>RM - Radio receiver operation</b> 1-5 - Step-by-step 1-3 - Opening	<b>1-5</b>	<b>1-3</b>
	<b>AM</b>	<b>AM - Operation of AUX1 plug-in control board</b> 1-5 - Step-by-step 1-3 - Opening	<b>1-5</b>	<b>1-3</b>
	<b>MP</b>	<b>MP - Start-up at maximum power</b> ON - During start-up it increases the thrust on obstacles to maximum OFF - During start-up, the thrust on obstacles is the one adjusted by <b>R 1-R2</b> .	<b>ON</b>	<b>OF</b>
	<b>PP</b>	<b>PP - Setting step-by-step sequence from command 1-5.</b> ON - Opening-Stop-Closing-Stop-Opening OF - Opening-Stop-Closing-Opening	<b>ON</b>	<b>OF</b>
<b>55</b>	<b>S5 - Duration of STOP in step-by-step sequence from command 1-5.</b> ON - Permanent OF - Temporary	<b>ON</b>	<b>OF</b>	

## 15.4 Second level menu - BA (Basic Adjustment)

Display	Description	Selections available
TC	<b>TC - Setting of automatic closing time [s]</b> It is set with different intervals of sensitivity. <ul style="list-style-type: none"> <li>from 0" to 59" with intervals of 1 second</li> <li>from 1' to 2' with intervals of 10 seconds</li> </ul>	00 59 1' 2' 1'00" <u>30</u>
RP	<b>RP - Adjustment of partial opening measurement [%]</b> Adjusts the percentage of operation in relation to the total opening of the automation. 10 - Minimum 99 - Maximum	10 99 30 <u>30</u>
TP	<b>TP - Setting of automatic closing time after partial opening [s]</b> It is set with different intervals of sensitivity. <ul style="list-style-type: none"> <li>from 0" to 59" with intervals of 1 second</li> <li>from 1' to 2' with intervals of 10 seconds</li> </ul>	00 59 1' 2' 30 <u>30</u>
VA	<b>VA - Opening speed [cm/s]</b>	10 30 20 <u>20</u>
VC	<b>VC - Closing speed [cm/s]</b>	10 30 20 <u>20</u>
R 1	<b>R1 - Adjustment of thrust on obstacles and motor current during opening. [%]</b> The control panel is fitted with a safety device which, when it detects an obstacle: <ul style="list-style-type: none"> <li>- stops the movement and, if outside the obstacle detection area, performs a reverse movement regulated by the selection <b>AP</b> → <b>DE</b>;</li> </ul> The obstacle detection area during opening is determined by the type of limit switch installed. If there is no limit switch, it is determined according to the selection <b>BA</b> → <b>00</b> . 00 - Minimum thrust 99 - Maximum thrust	00 99 50 <u>50</u>

Display	Description	Selections available
BA - Basic adjustment <b>R2</b>	<b>R2 - Adjustment of thrust on obstacles and motor current during closure. [%]</b> The control panel is fitted with a safety device which, when it detects an obstacle: - reverses the movement during closure operations outside the limit area for detecting obstacles; - stops the movement during closure operations within the limit area for detecting obstacles. The obstacle detection area during closure is determined by the type of limit switch installed. If there is no limit switch, it is determined according to the selection <b>BA</b> → <b>OC</b> . 00 - Minimum thrust 99 - Maximum thrust	

### 15.4.1 Additional BA level parameters that can be configured (available with **AT** → **AA** enabled)



Display	Description	Selections available
BA <b>DT</b> <b>ST</b> <b>TA</b> <b>TQ</b> <b>VM</b> <b>TD</b> <b>TU</b> <b>OB</b>	<b>DT - Adjustment of obstacle recognition time [s/100]</b> 10 - Minimum 60 - Maximum NB: the parameter is adjusted in hundredths of a second.	
	<b>ST - Adjustment of start time [s]</b> 0.5 - Minimum 3.0 - Maximum	
	<b>TA - Adjustment of acceleration time during opening [s]</b> 0.5 - Minimum 9.9 - Maximum	
	<b>TQ - Adjustment of acceleration time during closure [s]</b> 0.5 - Minimum 9.9 - Maximum	
	<b>VM - Initial movement speed [cm/s]</b> 00 - Minimum 15 - Maximum	
	<b>TD - Adjustment of deceleration time during opening [%]</b> Regulates the slope of the deceleration ramp during opening. 10 - Minimum 99 - Maximum	
	<b>TU - Adjustment of deceleration time during closure [%]</b> Regulates the slope of the deceleration ramp during opening. 10 - Minimum 99 - Maximum	
	<b>OB - Adjustment of deceleration distance during opening. [cm]</b> Indicates the distance from the end of the opening stroke for the start of the deceleration ramp. 05 - Minimum 99 - Maximum	

Display	Description	Selections available
	<b>OB - Adjustment of deceleration distance during closing. [cm]</b> Indicates the distance from the end of the closure stroke for the start of the deceleration ramp. 05 - Minimum 99 - Maximum	
	<b>PO - Adjustment of approach speed during opening [cm/s]</b> Indicates the speed from the end of the deceleration ramp to the end of the opening stroke 03 - Minimum 10 - Maximum NB: gradually increase the approach speed if there is a series of quick vibrations (chattering) in heavy gates installed with a slight incline.	
	<b>PC - Adjustment of approach speed during closing [cm/s]</b> Indicates the speed from the end of the deceleration ramp to the end of the closing stroke. 03 - Minimum 10 - Maximum	
	<b>OO - Obstacle detection limit during opening [cm]</b> Indicates the distance from the opening stop or after the detection of the opening limit switch $AP \rightarrow FA \rightarrow RA$ at which disengagement is deactivated. NB: not active if $AP \rightarrow FA \rightarrow Sx$ or if $AP \rightarrow FA \rightarrow Px$ .	
	<b>OC - Obstacle detection limit during closure [cm]</b> Indicates the distance from the closure stop or after the detection of the closure limit switch $AP \rightarrow FC \rightarrow RA$ at which reversal is deactivated. NB: not active if $AP \rightarrow FC \rightarrow Sx$ and if $AP \rightarrow FC \rightarrow Px$ .	
	<b>LR - Electric lock release time [s]</b> If enabled, this indicates the electric lock activation time at the start of every opening operation with the automation closed.	
	<b>FF - Function of output +LP-</b> 00 - courtesy light 01 - electric lock 02 - electric lock + release stroke 03 - ON-OFF flashing light 04 - ON-OFF flashing light for LED without oscillator 05 - fixed light (at 230V AC, or LED with internal oscillator) 06 - proportional indicator light for open gate (with signal of battery operation) 07 - fixed indicator light for open gate (automation not closed) 08 - automation closed (for fail-safe electromagnets) 09 - automation open 10 - automation moving (can also be used for electromagnets that need to be powered throughout the operation) 11 - automation opening 12 - automation closing 13 - maintenance alarm 14 - signal for batteries almost flat ON - output always active	

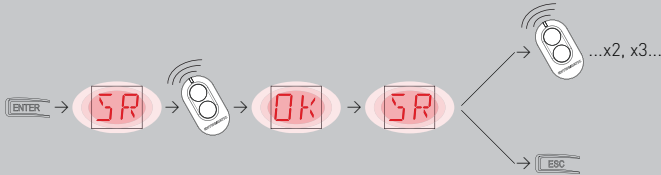
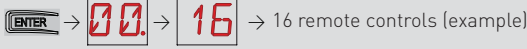

NB: make adjustments gradually and only after performing at least three complete operations to allow the control panel to be set correctly and detect any friction during operations.

# 15.5 Second level menu - RO (Radio Operations)

RO - Radio operations	<b>Display</b>	<b>Description</b>	
	SR	<p><b>SR - Remote control storage</b></p> <p>You can directly access the Remote control storage menu even with the display turned off, but only with the Display visualisation mode option set to 00 or 03:</p> <ul style="list-style-type: none"> <li>- for transmitting a remote control not present in the memory;</li> <li>- for transmitting an unstored channel of a remote control already present in the memory.</li> </ul>  <p>WARNING: if the display shows <b>NO</b> flashing, the remote control may already be stored.</p>	
	TX	<p><b>TX - Visualisation of counter showing remote controls stored</b></p> <p></p>	
MU	<p><b>MU - Indication of maximum number of remote controls that can be stored in the integrated memory</b></p> <p>You can store a maximum of 100 or 200 remote control codes.</p>  <p>20 - 200 remote controls that can be stored 10 - 100 remote controls that can be stored</p>	<p><b>Selections available</b></p> <div style="font-size: 2em; text-align: center;">20 10</div> <hr style="width: 50%; margin: auto;"/>	

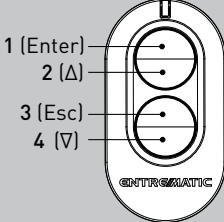

**WARNING:** selecting **MU** → **20** (200 remote controls), the configurations **U 1** and **U 2** saved with the **SF** → **SV** command will be lost. This also applies for the last configuration reloaded with **RL**. In addition, new configurations cannot be saved on **U 1** and **U 2**.

R0 - Radio operations

Display	Description	Selections available
<b>RK</b>	<p><b>RK - Menu navigation using remote control keyboard</b>                      ON - Enabled                      OF - Disabled</p> <p>With the display turned off, quickly type in the sequence of keys <b>3 3 2 4</b> <b>1</b> from the stored remote control you want to use.                      Make sure all the CH keys are stored.                      WARNING: during navigation with a remote control keyboard ALL the stored remote controls are inactive.</p>  <p>1 (Enter)                      2 (Δ)                      3 (Esc)                      4 (∇)</p> <p>To make viewing and adjustment easier (avoiding the need to continuously press the remote control), press the UP ↑ or DOWN ↓ key once to begin slowly scrolling through the parameters.                      This scrolling movement is faster if the UP ↑ or DOWN ↓ key is pressed twice.                      To stop the scrolling, press ENTER.                      To confirm your choice of parameter, press ENTER again.                      To test any new setting, switch off the display and issue an opening command using key <b>3</b>.                      Navigation using a remote control keyboard is automatically disabled after 4 minutes of inactivity or by setting <b>RK</b> → <b>OF</b>.</p>	<p>ON</p> <p>OF</p>

15.5.1 Additional BO level parameters that can be configured (available with **AT** → **AA** enabled)

Display	Description	Selections available
<b>R0</b>	<p><b>C1, C2, C3, C4 - Selection of CH1, CH2, CH3, CH4 function of stored remote control.</b>                      NO - No setting selected                      1-3 - Opening command                      1-4 - Closing command                      1-5 - Step-by-step command                      P3 - Partial opening command                      LG - Command to switch the courtesy light on/off                      1-9 - STOP command</p> <p>If even just one (any) CH key of the remote control is stored, the opening or step-by-step command is implemented.                      NB: the <b>1-3</b> (opening) and <b>1-5</b> (step-by-step) options are available as alternatives, and depend on the selection <b>BC</b> → <b>RM</b>.                      If 2-4 CH matched in a single remote control are stored, the functions matched in the factory with the CH keys are as follows:</p> <ul style="list-style-type: none"> <li>• CH1 = opening/step-by-step command</li> <li>• CH2 = partial opening command;</li> <li>• CH3 = courtesy light on/off command</li> <li>• CH4 = STOP command.</li> </ul>	<p>NO</p> <p>1-3</p> <p>1-4</p> <p>1-5</p> <p>P3</p> <p>LG</p> <p>1-9</p>

Display	Description	Selections available
RO	<b>ER - Deletion of a single remote control</b> 	
	<b>EA - Total memory deletion</b> 	
	<b>RE - Setting memory opening from remote control</b> OF - Disabled ON - Enabled When enabled (ON), the remote programming is activated. To store new remote controls without using the control panel, refer to the remote control instructions. NB: make sure you do not accidentally memorise unwanted remote controls.	ON OF
	<b>EP - Setting the coded area messages</b> If the possibility to receive coded messages is enabled, the control panel will be compatible with remote controls of the "ENCRYPTED" type.	ON OF



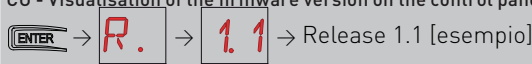
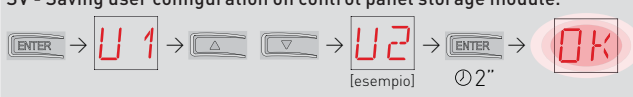
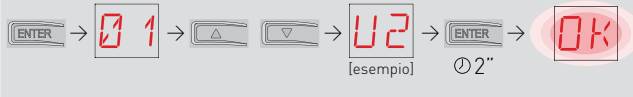



## 15.6 Second level menu - SF (Special Functions)

Display	Description	Selections available
SF - Special Functions	<b>CU - Visualisation of the firmware version on the control panel</b> 	
	<b>SV - Saving user configuration on control panel storage module.</b>  <p>By selecting <b>RO</b> → <b>MU</b> → <b>10</b> you can save up to 2 personalised configurations in memory positions <b>U 1</b> and <b>U 2</b> only with the storage module present on the control panel.</p> <p>WARNING: if <b>RO</b> → <b>MU</b> → <b>20</b> is selected, no user configuration can be saved on <b>U 1</b> and <b>U 2</b>.</p> <p>WARNING: if the display visualises <b>NO</b> flashing, the memory module may not be installed.</p>	U 1 U 2
	<b>RC - Configuration loading</b>  <p>It's possible to load the user configurations previously stored <b>U 1</b> and <b>U 2</b> on the memory module of the control panel.</p>	U 1 U 2

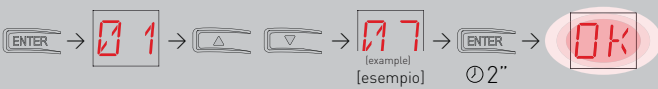
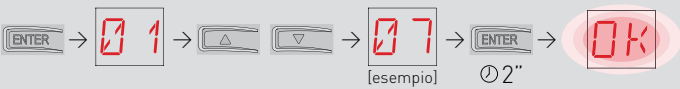



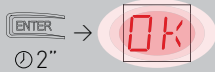
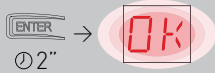

Display	Description
<b>RL</b>	<p><b>RL - Loading of last configuration set</b></p>  <p>⌀2"</p> <p>The control panel automatically saves the last configuration set, and keeps it memorised in the storage module. In the event of a fault or the replacement of the control panel, the last configuration of the automation can be restored by inserting the storage module and loading the last configuration set.</p>

### 15.6.1 Additional SF level parameters that can be configured (available with **AT** → **AA** enabled)



Display	Description
<b>SP</b>	<p><b>SP - Setting the password</b></p>  <p>NB: this can only be selected when the password is not set. Setting the password prevents unauthorised personnel from accessing selections and adjustments. You can delete the set password by selecting the sequence JR1=ON, JR1=OFF, JR1=ON.</p>
<b>IP</b>	<p><b>IP - Inserting the password</b></p>  <p>NB: this can only be selected when the password is set. When the password is not inserted, you can access the display mode regardless of the selection made with JR1. When the password is inserted, you can access in maintenance mode.</p>
<b>EU</b>	<p><b>EU - Deletion of user configurations and last configuration set in the storage module</b></p> 
<b>AL</b>	<p><b>AL - Alarm counter</b></p> <p>Used to view, in sequence, the counters of alarms that have been triggered at least once (alarm code + number of times triggered). With  and , you can scroll through all the counters and see all the alarms recorded.</p>
<b>AH</b>	<p><b>AH - Alarm log</b></p> <p>Used to view, in sequence, alarms that have been triggered (maximum 20). With  and , you can scroll through the entire alarm log. The display shows the alarm number and code, alternated. The highest number corresponds to the most recent alarm and the lowest number (0) corresponds to the oldest alarm.</p>

Display	Description
AR	<b>AR - Alarm reset</b> Resets all the alarms in the memory (counters and log).  ⓪2" NB: when the installation has been completed, you are advised to delete the alarms in order to facilitate future checks.
IM	<b>IM - Motor current visualisation</b>
TT	<b>TT - Display min / max temperatures recorded</b> - by pressing for 2 seconds the values are reset - minimum value with active right point
TF	<b>TF - Limit switch test</b> Only FA / FC are displayed when the respective limit switches are configured and active. If the limit switches are active but not configured: - FA = N.O. (both active points) - FC = NO (no active point)
UP	<b>UP - Firmware update</b> Activates the card bootloader in order to update the firmware.  ⓪2"



## 15.7 Second level menu - CC (Cycles Counter)

Display	Description
CV	<b>CV - Display of total operations counter</b> 
CP	<b>CP - Display of partial operations counter</b> 
CH	<b>CH - Display of power supply hour counter</b> 
BH	<b>BH - Visualisation of counter for power supply hours via battery</b> 

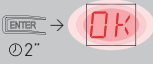
## 15.7.1 Additional CC level parameters that can be configured (available with **AT** → **AA** enabled)

Display	Description	Selections available
CC	<b>CA - Setting the maintenance alarm</b> <b>(factory setting - alarm deactivated: 0.0 00. 00).</b> You can set the required number of operations (regarding the partial operations counter) for signalling the maintenance alarm. When the set number of operations is reached, the alarm message appears on the display <b>V 0</b> .  Example: Setting the maintenance alarm after 700 operations (00) (07) (00) 	
	<b>OA - Selecting maintenance alarm display mode</b> 00 - Visualisation on display (alarm message <b>V 0</b> ) 01 - Visualisation on flashing light (with the automation idle, 4 flashes are made and then repeated every hour) and on display (alarm message <b>V 0</b> ). 02 - Visualisation on "open gate" indicator light (with the automation closed, 4 flashes are made and then repeated every hour) and on display (alarm message <b>V 0</b> ). 	
	<b>ZP - Reset of partial operations counter</b>  For correct functioning, you are advised to reset the partial operations counter: - after maintenance work; - after setting the maintenance alarm interval.	

## 15.8 Second level menu - EM (Energy Management)

Display	Description	Selections available
EM - Energy management	<b>PV - Solar panel power supply (panels not supplied)</b> ON - Enabled OF - Disabled 	
	<b>ES - Energy-saving (disconnection of accessories connected to terminals 0-1 when the automation is in standby)</b> ON - Enabled (the red point on the right of the display flashes every 5 s. Output +LP- is managed only for courtesy light). OF - Disabled  Power supply disconnection mode is activated after 15 s with the gate closed, or when the gate is idle and automatic closure is not enabled. The automation resumes its normal operation when a command is received on the radio board (6ZENRS-ZENPRS) or following a contact 30-5, 30-20. <b>WARNING:</b> if you use accessories that need to remain powered even with Energy Saving is enabled (e.g. LAN4 or GOPAV), set the jumper JR5 relating to the slot used on power supply 0-30. 	

Display	Description	Selections available
EM LB	<b>LB - Indication that batteries are almost flat</b>	
	00 - Visualisation on display (alarm message <b>B0</b> )	
	01 - Visualisation on flashing light (with the automation idle, 2 flashes are made and then repeated every hour) and on display (alarm message <b>B0</b> )	
	02 - Visualisation on "open gate" indicator light (with the automation closed, 2 flashes are made and then repeated every hour) and on display (alarm message <b>B0</b> )	

### 15.8.1 Additional EM level parameters that can be configured (available with **AT** → **AA** enabled)

Display	Description	Selections available
EM LL	<b>LL - Voltage threshold for indicating that batteries are almost flat (V)</b>	
	17 - Minimum 24 - Maximum NB: it is set with an interval of sensitivity of 0.5 V shown when the decimal point on the right lights up.	
EM BT	<b>BT - Battery mode</b>	
	00 - Anti-panic (performs the opening operation following a mains supply failure. The automation opens but does not accept any other commands until the mains supply has been restored).	
	01 - Continuous operation - the last operation performed before control panel switch-off will be an opening.	
	02 - Continuous operation - the last operation performed before control panel switch-off will be a closure.	

### 15.9 Second level menu - AP (Advanced Parameters)

Display	Description	Selections available
AP - Advanced Parameters FA	<b>FA - Selection of opening limit switch mode</b>	
	NO - None	
	SX - Stop limit switch (after activation, the gate stops its movement) PX - Proximity limit switch (after activation, the gate continues as far as the end stop and any obstacle is considered a stop)	
AP - Advanced Parameters FC	<b>FC - Selection of closing limit switch mode</b>	
	NO - None	
	SX - Stop limit switch (after activation, the gate stops its movement) PX - Proximity limit switch (after activation, the gate continues as far as the end stop and any obstacle is considered a stop)	

AP - Advanced Parameters

Display	Description	Selections available
<b>D6</b>	<b>D6 - Selection of device connected to terminals 1-6</b> NO - None PH - Photocells P41 - Photocells with safety test SE - Safety edge (if contact 1-6 opens, there is a disengagement of 10cm after the stop) S41 - Safety edge with safety test (if contact 1-6 opens, after the stop there is a disengagement of a duration depending on the selection <b>AP</b> → <b>DE</b> )	NO PH P41 SE S41
<b>D8</b>	<b>D8 - Selection of device connected to terminals 1-8</b> NO - None PH - Photocells P41 - Photocells with safety test SE - Safety edge S41 - Safety edge with safety test	NO PH P41 SE S41
<b>R9</b>	<b>R9 - Enabling automatic closing after command 1-9 via radio (STOP).</b> ON - Enabled OF - Disabled When enabled (ON), after a command 1-9 via radio, the automation carries out automatic closing (if enabled), after the set time.	ON OF
<b>68</b>	<b>68 - Selection of the device simultaneously connected to terminals 1-6 and 1-8</b> NO - None SE - Safety edge S41 - Safety edge with safety test If different from NO, the simultaneous opening of inputs 1-6 and 1-8 causes: - movement stop and reversal during a closing operation - movement stop and disengagement of a duration depending on the selection <b>AP</b> → <b>DE</b> during an opening operation	NO SE S41
<b>D5</b>	<b>D5 - Setting of display visualisation mode</b> 00 - No visualisation 01 - Commands and safety devices with radio test Display of countdown to automatic closure. 02 - Automation status 03 - Commands and safety devices NB: the setting <b>01</b> allows you to see when a radio transmission is received, for range checks.	00 01 02 03



NB: make adjustments gradually and only after performing at least three complete operations to allow the control panel to be set correctly and detect any friction during operations.

### 15.9.1 Additional AP level parameters that can be configured (available with **AT** → **AA** enabled)

Display	Description	Selections available
<b>20</b>	<b>20 - Partial opening command of terminal 1-20</b> P3 - Partial opening command 1-2 - Enabling of automatic closure 1-9 - Stop input	P3 1-2 1-9
<b>LU</b>	<b>LU - Setting the courtesy light switch-on time (s)</b> To enable the parameter, set the selection <b>BA</b> → <b>FF</b> as "courtesy light". It is set with different intervals of sensitivity. NO - Disabled - from 01" to 59" with intervals of 1 second - from 1' to 2' with intervals of 10 seconds - from 2' to 3' with intervals of 1 minute ON - Permanently enabled (switched off via remote control) NB: the courtesy light switches on at the start of each operation.	NO 0 1 5 9 1' 2' 2' 3' ON
<b>LG</b>	<b>LG - Switch-on time for independently commanded courtesy light [s]</b> To enable the parameter, set the selection <b>BA</b> → <b>FF</b> as "courtesy light". It is set with different intervals of sensitivity. NO - Disabled - from 01" to 59" with intervals of 1 second - from 1' to 2' with intervals of 10 seconds - from 2' to 3' with intervals of 1 minute ON - Switched on and off with remote control NB: the switching on of the light does not depend on the start of an operation, but can be commanded separately using the special remote control key.	NO 0 1 5 9 1' 2' 2' 3' ON
<b>PT</b>	<b>PT - Fixed partial opening</b> ON - Enabled OF - Disabled If ON, a partial opening command given on the partial opening position is ignored. With contact 1-20 closed (for example with the timer or manual selector), the gate will partially open. If it is then fully opened (command 1-3) and reclosed (even with automatic closure), it will stop at the partial opening position.	ON OF
<b>DE</b>	<b>DE - Disengagement setting if an edge is triggered [cm]</b> Regulates the disengagement distance when an edge (active or passive) is triggered during opening or closure. 00 - Deactivated 20 - Maximum	00 20 10
<b>DO</b>	<b>DO - Setting of disengagement on stop during opening [mm]</b> Regulates the distance of the disengagement on the mechanical opening stop. 00 - Disabled 15 - Maximum NB: not active if <b>FA</b> → <b>SX</b>	00 15 07

Display	Description	Selections available
<b>DC</b>	<b>DC - Setting of disengagement on stop during closure [mm]</b> Regulates the distance of the disengagement on the mechanical opening stop. 00 - Disabled 99 - Maximum NB: not active if <b>FC</b> → <b>SX</b>	00 ▶ 15 <u>07</u>
<b>OT</b>	<b>OT - Selection of type of obstacle identification</b> 00 - Overcurrent or gate stopped 01 - Overcurrent 02 - Door stopped NB: the obstacle identification for "door stopped" is faster but more sensitive.	00 0 1 02 <u>—</u>
<b>CR</b>	<b>CR - Stroke estimate correction [%]</b> DO NOT USE (diagnostic purposes only)	-- 9 ▶ + 9
<b>SM</b>	<b>SM - Selection of operating mode of device connected to terminals 1-6</b> 00 - During the operation, the opening of the safety contact stops the movement (with disengagement if <b>DB</b> → <b>SE / S4</b> ). 01 - During the operation, the opening of the safety contact stops the movement (with disengagement if <b>DB</b> → <b>SE / S4</b> ). When the contact closes again, the operation is resumed. 02 - During the operation, opening of the safety contact stops the movement (with disengagement if <b>DB</b> → <b>SE / S4</b> ). When the contact closes again, an opening operation is performed. 03 - During the closing operation, the opening of the safety contact reverses the movement. During the opening operation, the safety device is ignored. 04 - During the opening operation, the opening of the safety contact stops the movement (with disengagement if <b>DB</b> → <b>SE / S4</b> ). When the contact closes again, the opening operation is resumed. During the closing operation, the safety device is ignored. 05 - During the closing operation, the opening of the safety contact stops and reverses the movement. During the opening operation, the opening of the safety contact stops the movement (with disengagement if <b>DB</b> → <b>SE / S4</b> ).	00 <u>—</u> 01 02 03 04 05
<b>TN</b>	<b>TN - Setting of intervention temperature for the NIO electronic anti-freeze system and automatic HS ramps [°C]</b> This value does not refer to the ambient temperature, but to the internal control panel temperature.	-- 9 ▶ 50 <u>20</u>
<b>TH</b>	<b>TH - High temperature protection enable.</b> If ON, the automatic reclosing time is extended when the maximum switchboard temperature is reached. If the condition persists, all the controls are disabled.	<u>ON</u> OF
<b>HS</b>	<b>HS - Automatic ramp adjustment</b> ON - Enabled OF - Disabled When enabled (ON), at low ambient temperatures the start time <b>ST</b> increases up to the maximum value and the acceleration time <b>TA</b> and <b>TB</b> diminishes to the minimum value. NB: for correct operation, the control panel must be exposed to the same ambient temperature as the motors. The intervention temperature can be set with the selection <b>AP</b> → <b>TN</b> .	ON <u>—</u> OF

AP	Display	Description	Selections available
	TB	TB - Permanent display of the internal control panel temperature [°C]	ON OF <u>        </u>
	WO	WO - Setting of pre-flashing time on opening [s] Adjustment of the lead time for the switch-on of the flashing light, in relation to the start of the opening operation from a voluntary command. 00 - Minimum 05 - Maximum	0005 00 <u>        </u>
	WC	WC - Setting of pre-flashing time on closing [s] Adjustment of the lead time for the switch-on of the flashing light, in relation to the start of the closing operation from a voluntary command. 00 - Minimum 05 - Maximum	0005 00'' <u>        </u>
	TS	TS - Setting of renewal of automatic closing time after safety device release [%] 00 - Minimum 99 - Maximum	0099 99 <u>        </u>
VR	VR - Setting of learning speed [cm/s]	0510 8 <u>        </u>	

## 16. Signals visualised on the display

**i** NB: depending on the type of automation and control panel, certain visualisations may not be available.





### 16.1 Display of automation status









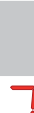

**i** NB: the automation status display mode is only visible with Display visualisation mode set to 02.

AP ▶ DS ▶ 02

Display	Description
DM ▶ RT	
[-	Automation closed
[-	Automation closed Release door open
	Automation open
	Automation open Release door open



	Automation stopped in intermediate position
	Automation stopped in intermediate position Release door open
	Automation closing
	Automation that slows down during closing.
	Automation opening
	Automation that slows down during opening.

Display	Description
	
	Automation closed
	Automation closed Release door open
	Automation open
	Automation open Release door open
	Automation stopped in intermediate position
	Automation stopped in intermediate position Release door open
	Automation closing
	Automation that slows down during closing.
	Automation opening
	Automation that slows down during opening.

## 16.2 Display of safety devices and commands

**i** NB: the safety device and command display mode is only visible with Display visualisation mode set at 01 or 03.

AP → DS → 01

AP → DS → 03





















Display	Description	Display	Description
1-2	1-2 - Automatic closing activation command	68	68 - Partial opening command
1-3	1-3 - Opening command	1-6	1-6 - Safety device with opening and closing stop
1-4	1-4 - Closing command	51	S1 - Detection of stop during closure
1-5	1-5 - Step-by-step command	1-8	1-8 - Safety with closing reversal
P3	P3 - Partial opening command.	1-9	1-9 - STOP command
4P	4P - Closing command with operator present	3P	3P - Opening command with operator present
RX	RX - Radio reception (of any memorised key of a transmitter present in the memory)	52	S2 - Detection of stop during opening
NX	NX - Radio reception (of any non-memorised key) NB: with the selection AP → DS → 01, it is also visualised when a command is received from a non-stored transmitter.	00	00 - Obstacle detection area reached during opening
		0C	0C - Obstacle detection area reached during closure
EX	EX - Rolling-code radio reception out of sequence	RV	RV - Enabling/disabling of built-in radio receiver via RDX
EP	EP - Radio reception not complying with the parameter configuration RO → EP	MQ	MQ - Learning operation of mechanical end stops in progress
CX	CX - Command received from AUX1 board	HT	HT - Heating of the motors (NIO function) in progress
FC	FC - Closure limit switch	HS	HS - Sharp NIO start-up
FA	FA - Opening limit switch	J1	JR1 - Variation of the JR1 jumper status
SW	SW - Release door open. When the release door is closed, the control panel performs a RESET (alarm XX)		

## 16.3 Visualisation of alarms and faults



**WARNING:** the visualisation of alarms and faults is possible with any visualisation selection. The signalling of alarm messages takes priority over all other displays.

Type of alarm	Display	Description	Operation
Mechanical alarm	M3	M3 - Automation blocked	Check the mechanical parts.
	M4	M4 - Motor short circuit	Check connection of motor.
	M8	M8 - Stroke too long	Check the rack / chain belt
	M9	M8 - Stroke too short	Manually check that the gate moves freely.
	MB	MB - Absence of motor during an operation.	Check connection of motor.
	MD	MD - Irregular operation of the opening limit switch If the limit switch is configured but can't be found, each stop (from the OB deceleration start point) is seen as an obstacle and indicated with MD.	Check connection of the opening limit switch.
	ME	ME - Irregular operation of the closure limit switch If the limit switch is configured but can't be found, each stop (from the CB deceleration start point) is seen as an obstacle and indicated with ME.	Check connection of the closure limit switch.
	MI	MI - Detection of fifth consecutive obstacle.	Check for the presence of permanent obstacles along the stroke of the automation.
	OD	OD - Obstacle during opening	Check for the presence of obstacles along the automation stroke.
	OE	OE - Obstacle during closure	Check for the presence of obstacles along the automation stroke.
	OF	OF - Automation blocked on opening	Check the mechanical parts and make sure there are no obstacles along the automation stroke.
OG	OG - Automation blocked on closure	Check the mechanical parts and make sure there are no obstacles along the automation stroke.	
Power supply Settings	S6	S6 - Incorrect setting of safety device test	Check the configuration of parameters <b>I6, I8, 68</b> . If <b>68</b> → <b>S4, I6</b> and <b>I8</b> cannot be <b>P4</b> or <b>S4</b> .

Type of alarm	Display	Description	Operation
Service alarm		V0 - Request for maintenance intervention	Proceed with the scheduled maintenance intervention.
Internal control panel alarm		I5 - No voltage 0-1 (faulty voltage regulator or short-circuit on accessories)	Check there is no short circuit in connection 0-1. If the problem persists, replace the control panel.
		I6 - Excessive voltage 0-1 (faulty voltage regulator)	Replace the control panel.
		I7 - Internal parameter error - value outside limits	Reset. If the problem persists, replace the control panel.
		I8 - Program sequence error	Reset. If the problem persists, replace the control panel.
		IA - Internal parameter error (EEPROM/FLASH)	Reset. If the problem persists, replace the control panel.
		IB - Internal parameter error (RAM)	Reset. If the problem persists, replace the control panel.
		IC - Operation time-out error (>5 min or >7 min in learning mode)	Manually check that the gate moves freely. If the problem persists, replace the control panel.
		IE - Power supply circuit fault	Reset. If the problem persists, replace the control panel.
		IM - MOSFET alarm - motor in short circuit or always ON	Reset. If the problem persists, replace the control panel. Check the settings / operating of any limit switches.
		IO - Interrupted motor power circuit (motor MOSFET open or always OFF)	Reset. If the problem persists, replace the control panel.
		IR - Motor relay error	Reset. If the problem persists, replace the control panel.
		IS - Error on motor current read circuit test	Reset. If the problem persists, replace the control panel.
		IU - Error on motor voltage read circuit test	Reset. If the problem persists, replace the control panel.
		TH - Intervention of high temperature safety device	Do not carry out any operations. If the problem persists, contact Technical Service.
		VH - Automation blocked due to high temperature	Do not carry out any operations. If the problem persists, contact Technical Service.
		XX - Firmware reset commanded by the simultaneous pressing of the  +  keys.	
		WD - Firmware reset not commanded	

Type of alarm	Display	Description	Operation
Radio operations alarm	R0	R0 - Insertion of a storage module containing over 100 stored remote controls Warning: the <b>RO</b> → <b>MU</b> → <b>20</b> setting is made automatically.	To save the system configurations on the storage module, delete any stored remote controls and bring the total to less than 100. Set <b>RO</b> → <b>MU</b> → <b>10</b> .
	R3	R3 - Storage module not detected	Insert a storage module.
	R4	R4 - Storage module not compatible with the control panel	Insert a compatible storage module.
	R5	R5 - No serial communication with the storage module	Replace the storage module.
	R6	R6 - Insertion of a specific storage module for testing	
Power supply alarm	P0	P0 - No mains voltage	Check the control panel is powered correctly. Check the line fuse. Check the mains power supply.
	P1	P1 - Microswitch voltage too low	Check the control panel is powered correctly.
Battery alarm	B0	B0 - Battery almost flat	Check battery voltage. Replace battery.
Accessories alarm	A0	A0 - Failure of test of safety sensor on contact 6	Check the device SOFA1-A2 is working correctly. If the supplementary SOF board is not inserted, check the safety test is disabled.
	A1	A1 - Simultaneous safety sensor test on contacts 6 and 8 failed	Check the wiring and correct operation of the safety sensor.
	A3	A3 - Failure of test of safety sensor on contact 8	Check the device SOFA1-A2 is working correctly. If the supplementary SOF board is not inserted, check the safety test is disabled.
	A7	A7 - Incorrect connection of contact 9 to terminal 41	Check that terminal 1 and 9 are correctly connected.
	A9	A9 - Overload on output +LP-	Check the device connected to output +LP- is working properly.

# 17. Troubleshooting

Problem	Possible cause	Alarm signalling	Operation	
The control panel does not switch on	No power supply.		Check the power supply cable and the relative wiring	
The automation does not open or close.	No power.		Check power supply cable.	
	Short circuited accessories	<b>IS</b>	Disconnect all accessories from terminals 0-1 (a voltage of 24V= must be present) and reconnect them one at a time. Contact Technical Service	
	Blown line fuse.		Replace fuse.	
	Safety contacts are open.	<b>I-6</b> <b>68</b>	<b>I-8</b>	Check that the safety contacts are closed correctly (NC).
	Safety contacts not correctly connected or self-controlled safety edge not functioning correctly.	<b>A0</b> <b>A1</b> <b>A3</b>	<b>I-6</b> <b>I-8</b> <b>68</b>	Check connections to terminals 6-8 on control panel and connections to the self-controlled safety edge.
	Photocells activated.	<b>I-6</b>	<b>I-8</b>	Check that the photocells are clean and operating correctly.
	The automatic closure does not work.			Issue any command. If the problem persists, contact Technical Service
	Motor fault	<b>M3</b> <b>M4</b>		Check motor connection, if the problem persists, contact Technical Service.
	Mechanical fault	<b>M3</b> <b>M8</b>		Check the rack and transmission chain, and/or the mechanical parts.
	Release microswitch open	<b>SW</b>		Check that the hatch is closed correctly and the microswitch makes contact.
	Faulty control panel	<b>I7</b> <b>I8</b> <b>IA</b> <b>IB</b>	<b>IE</b> <b>IM</b> <b>IO</b> <b>IR</b>	Contact Technical Service
Both limit switches are active.	<b>FA</b> <b>FC.</b>		Check the connection of the limit switches.	
The external safety devices are not activated.	Incorrect connections between the photocells and the control panel.		Check that <b>I-6 / I-8</b> is displayed Connect NC safety contacts together in series and remove any jumpers on the control panel terminal board.	
			Check the setting of <b>AP</b> → <b>I6</b> and <b>AP</b> → <b>I8</b> .	
The automation opens/closes briefly and then stops.	There is a presence of friction.	<b>MI</b> <b>M9</b> <b>IC</b>	Manually check that the automation moves freely and check the <b>R1/R2</b> adjustment Contact Technical Service	

Problem	Possible cause	Alarm signalling	Operation
The remote control has limited range and does not work with the automation moving.	The radio transmission is impeded by metal structures and reinforced concrete walls.		Install the antenna outside.
			Replace the transmitter batteries.
The remote control does not work	No storage module or incorrect storage module.	R0	Switch the automation off and plug in the correct storage module.
		R3	Check the correct memorisation of the transmitters on the built-in radio. If there is a fault with the radio receiver that is built into the control panel, the remote control codes can be read by removing the storage module.
		R5	
The flashing light is not working	The wires of the flashing light are detached or have short circuited.	A9	Check the connections. If the problem persists, contact Technical Service.





# Operating instructions

## General precautions for safe use



- Failure to observe the information in the User Manual may lead to personal injury or damage to the equipment. These instructions must be kept and forwarded to all possible future users of the system.
- The sliding gate must only be used for the specific purpose for which it was designed. Any other use should be considered improper and therefore dangerous. The manufacturer cannot be held responsible for any damage caused by improper, incorrect or unreasonable use.
- Do not use the sliding gate if it needs repairing or adjusting. Disconnect the power supply when carrying out cleaning or maintenance tasks.
- The motorised gate may be used by children over the age of 8 and by people with reduced physical, sensorial or mental abilities, or lack of experience or knowledge, as long as they are properly supervised or have been instructed in the safe use of the device and the relative hazards.
- Any cleaning or maintenance work by the user must be carried out directly by a responsible person or under his/her supervision.
- Do not allow children to play or stay near the sliding gate. Keep remote controls and/or any other command devices out of the reach of children, to prevent the sliding gate being accidentally activated.

# Manual release instructions

In the event of a fault or power failure, insert the key and turn it clockwise and completely open the hatch. Manually open the gate.

To lock the gate again, close the hatch, turn the key anticlockwise and remove the key.

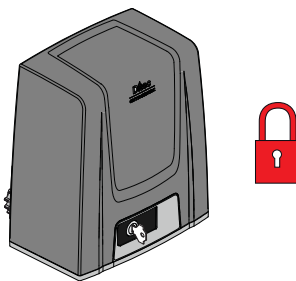

**WARNING:** the gate lock and release operations must be performed with the motor idle. Do not enter within the operating range of the gate.



When the hatch is closed but the key is still horizontal, the release microswitch is open and all manoeuvres are prevented.

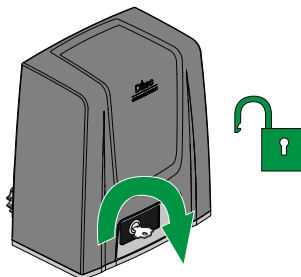





# Technical specifications

	ION4	ION6
Maximum stroke	12 m	
Maximum gate weight	400 kg	600 kg
Gate speed	0.1 - 0.25 m/s	0.1 - 0.3 m/s
Thrust	200N nominal, 600N start-up	300N nominal, 800N start-up
Power supply	230 V~ 50/60Hz	
Power absorption	0.5 A	
Fuse	T1 A	T1.6 A
Power	115W	
Intermittence	80 cycles/day, 30 continuous cycles	
Lifespan	From 50,000 to 150,000 cycles, depending on the conditions indicated in table x.x (see the product lifespan charts)	
IP degree of protection	34	
Usage temperature	-20°C / +55°C	
Product size	300 x 260 x 195	
Control panel	LCU48	
Motor output	24V ~ 10A max	
Power supply to accessories 0-1	24V ~ 0.3 A	
Radio frequency	433.92 MHz	
Storable radio codes	100 / 200 [see RO → MU → 20/10]	

# Regular safety checks and safety accessories

To meet the national/international requisites and avoid any malfunctioning or risk of injury, carry out the following operations and checks at least once every 6 months (or according to the frequency of use of the automation).

You are advised to have repairs and adjustments carried out by qualified personnel. Disconnect the power supply [A] when carrying out cleaning or maintenance tasks.

Task	In the event of problems
Disconnect the power supply and: <ul style="list-style-type: none"> <li>visually check the automation [1].</li> <li>check the electrical wires [B].</li> <li>check the condition of the gate [C] and the fixing brackets, and make sure the sliding movement is smooth and even.</li> <li>clean the slide mechanism, rack and pinion.</li> <li>lubricate the rack and pinion.</li> <li>make regular checks to ensure the photocells are clean. Do not use alkaline-based products. Do not use high pressure water jets. The automatic system, function selector switches and photocells could get damaged. Do not use polishing detergents. Do not rub with abrasive products, as they could cause damage.</li> </ul>	
Reconnect the power supply, then check: <ul style="list-style-type: none"> <li>the limit switches (if fitted) are working correctly</li> <li>the flashing light [3] is working correctly.</li> <li>the power adjustments are correct (this operation must be carried out by qualified personnel)</li> <li>the command devices [2] - [4] (if fitted) are working correctly</li> <li>the safety devices [5] - [6] - [7] (if fitted) are working correctly. If the gate detects an obstacle while it is opening or closing, it must reverse its movement or stop.</li> </ul>	 
In the event of malfunctioning or ALARM, you must CONTACT CUSTOMER SERVICE and inform them of the alarm visualised by the display.	

The following safety devices can be installed to protect the danger areas (in accordance with EN 12453 and EN 12445):

- 5** Safety photocells
- 6** Safety edge
- 7** Radio system for safety edges

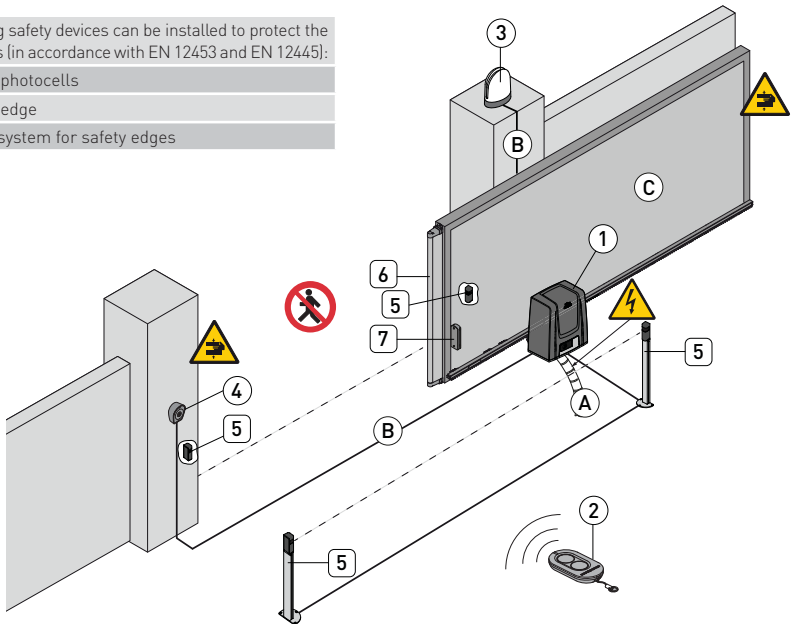

---

# ENTRE//MATIC



**Entrematic Group AB**  
Lodjursgatan 10  
SE-261 44, Landskrona  
Sweden  
[www.entrematic.com](http://www.entrematic.com)

